

3skeng Datasheet

3skeng is a 3D engineering extension for Trimble SketchUp, continuously developed and improved by software specialists to support their co-working engineers during their engineering projects. 3skeng enables fast initial designs and is able to apply changes in real-time during the design process of piping, ventilation, steelwork and much more...



3skeng List Tool

3skeng List adds spreadsheet capabilities to SketchUp. Our brand-new extension allows you to interact and work with SketchUp entities in data-based views. List, filter, sort and multi-edit. Create a bill of materials, a parts list or a report and export it to Excel (.XLSX).

Work more efficiently with 3skeng List

Powerful and interactive filtering, sorting and editing features help you to work most efficiently even in very large models. 3skeng List is not only helpful for editing element properties but also for making both complex and large selections that might be impossible to make otherwise. The spreadsheet view is always in sync with the 3D model. Changing data within 3skeng List (e.g. coordinates or name properties) results in immediate changes in the SketchUp model and vice versa! Sub-Selections are highlighted interactively in the 3D view.

[YouTube Video "Work more efficiently with 3skeng List"](#)

3skeng List keeps your model clean

3skeng List was designed to support professionals in their everyday work. It is packed with features that help to keep the model clean or find and solve errors. You can find duplicate entities, convert multiple groups to components or replace multiple components with another component of the selection. Round coordinates to the precision you prefer. Having a clean model is the foundation for high quality results.

[YouTube Video "3skeng List keeps your model clean"](#)

3skeng List exports your meta data

Of course, all spreadsheet views can be exported nicely formatted to Excel (.xlsx file format), or copied as plain text directly to the clipboard. You can use the definition, instance, layer and material names to add custom data columns to your components (by using the character "^" as separator in the names). Save your filter and column settings in customized list views to reuse them for repeating work. Tip: Referencing exported Excel spreadsheets in prepared Excel templates or in Trimble Layout gives you a fluent workflow for fast and reliable report generation!

[YouTube Video "3skeng List exports your meta data"](#)



3skeng Pipe Tool

3skeng Pipe Tool using the conceptual mode

All you need to model conceptual pipelines is integrated in this tool.

Pipes, T-pieces, Y-pieces, reducers as well as elbows are generated and connected in a smooth workflow with only few mouse-clicks. You have access to the most common standards (ANSI, ASME, ISO EN and JIS) and determine the dimensions of fittings with only a few clicks. Magnetic points and a memory function are powerful parts of the tool and assist your customers in the process.

3skeng Pipe Tool using the detail mode with libraries

The detail mode gives access to detail libraries with dimensions that are actually available on the market. The embedded auto-pipe function helps you to connect 3skeng components and allows you to select one of the possible configurations. Auto-Pipe is available for both conceptual and detail mode.

NEW: Selected libraries for 3skeng 2019 (see links in library list) now include the information "manufacturer" and "order number", usable with 3skeng Label and 3skeng List.

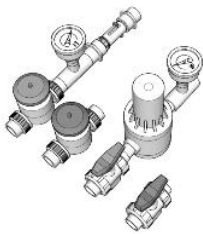

Plastic

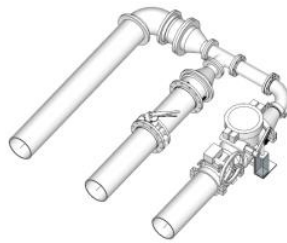

Ductile Iron

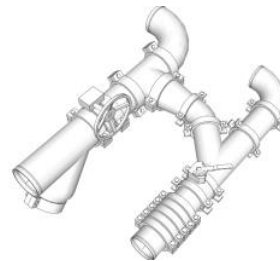

Grooved Steel



Steel/Stainless Steel

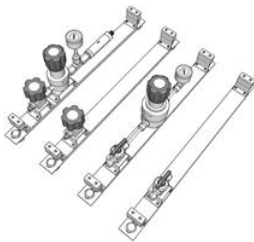

Stainless Steel Pure use



Ventilation-Exhaust

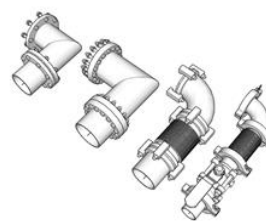

High Vacuum

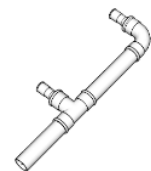

Copper

Available libraries for 3skeng Pipe

Plastic

- Imperial CPVC
- Imperial PVC DWV Piping (Drain-Waste-Ventilation)
- Imperial Fiberglass
- Metric PE80/PE100 [+GF+ ecoFIT \(PE\)](#)
- Metric PE-HD
- Metric PP [+GF+ PROGEF Standard \(PP\)](#)
- Metric PVC-C
- Metric PVC-U [+GF+ PVC-U](#)
- Metric PVDF/PVDF-HP
- [+GF+ SYGEF Standard \(PVDF\)](#) & [SYGEF Plus \(PVDF-HP\)](#)

Ductile Iron

- Imperial Ductile Iron with grooved connection (AWWA)
- Imperial Ductile Iron with mechanical joint & flanged connection (AWWA)

Steel

- Imperial Steel B36.10M
- Metric Steel Piping
- Metric Steel Piping Pressing Socket

Steel (Grooved Connection)

- Met-Imp Steel Grooved Piping 2-12in
- Met-Imp Steel Grooved Piping 14-60in
- Imperial/Metric Steel Sprinkler with grooved connection

Stainless Steel

- Imperial Stainless Steel B36.19M
- Metric Stainless Steel Piping, JIS
- Metric Stainless Steel Piping
- Metric Stainless Steel Piping, DIN EN 10357
- Metric Stainless Steel Pressing Socket

Stainless Steel (Pure Use)

- Imperial Stainless Steel Tubing for pure use
- Metric Stainless Steel Tubing for pure use, JIS

Ventilation and Exhaust Duct

- Imperial Stainless Steel Ductwork
- Imperial Galvanized Steel Ductwork (Plug Joint)
- Metric Stainless Steel Ductwork (Flanged)
- Metric Galvanized Steel Ductwork (Plug Joint)
- Metric Galvanized Steel Ductwork (Flanged)

High Vacuum

- Stainless Steel Vacuum CF/UHV
- Stainless Steel Vacuum ISO-F
- Stainless Steel Vacuum ISO-K
- Stainless Steel Vacuum ISO-KF

Copper

- Metric Copper Pressing Socket



3skeng Mount Tool

All you need to draw secondary/support steelwork models with proper fittings, supports and more. A memory function assists you in the process. Available libraries allow you to choose from different channel types.

The "Mount Tool" recognizes **3skeng Pipe** elements and assists by a) proper **pre-selection** from the available variety of pipe and duct clips and b) **auto-alignment** of rotation, position and elevation simply by double-click.

The "Mount Tool" also recognizes **3skeng Steelwork** elements to correctly attach supports to the top of steel beam flanges and beam clamps to the side of steel beam flanges.

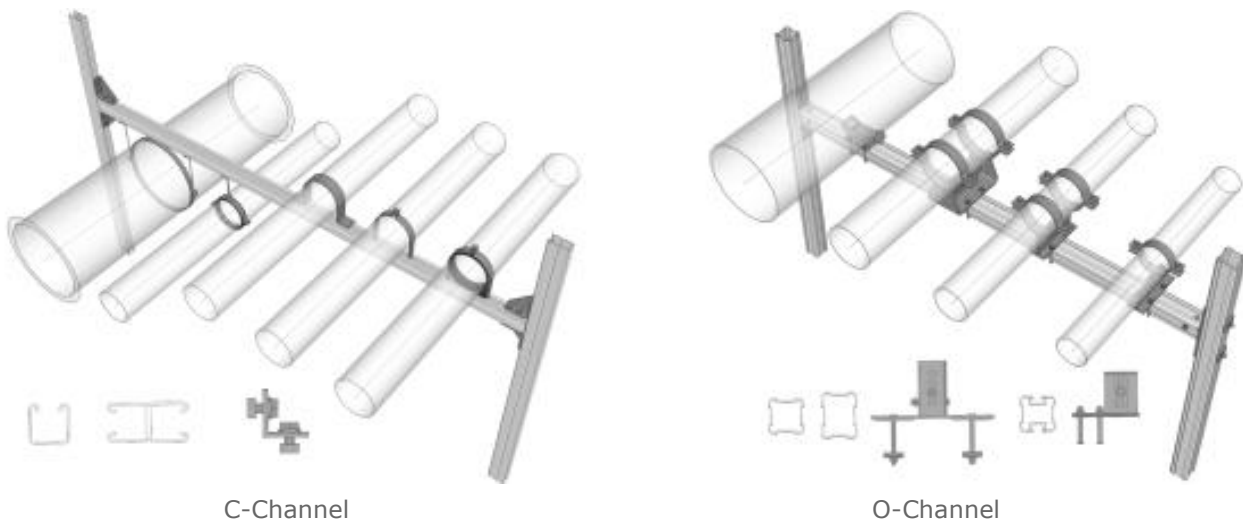

Available libraries for 3skeng Mount:

- Threaded Rods & Pipe / Duct Support
- C-Channel
- O-Channel (Heavy Duty)

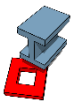

3skeng Steelwork Tool

All you need to draw Steelwork models with straight and chamfered segments. A memory function assists in the process.

An extensive built-in library allows you to choose from many different standards from all over the world.



3skeng Channel Tool

All you need to draw (conceptual) Channel (Ventilation) models is integrated in this tool.

Straight channels, t-pieces, reducers (also changeover to round for pipe tool) and elbows (round and square) are generated and connected in a smooth workflow with only few mouse-clicks.

You can determine channel dimensions and lengths with only a few clicks. Magnetic points and a memory function are powerful parts of the tool and assist in the process.

3skeng Shared Features

3skeng tools come with features that make it very easy to apply changes, add labels and create bills of material (BOM).



3skeng Edit and Rotate

This tool helps you to modify the model in all feasible degrees of freedom. The speed of the tool allows you show changes and suggestions live in meetings - without anyone losing interest! The tool is intuitive in a way that nearly follows your ideas by itself. Use magnetic points for reference or the input of numeric values in the familiar SketchUp way. Works with 3skeng Pipe, Channel and Steelwork.



3skeng Connect

With this tool you can rearrange or copy already generated Pipeline elements. Magnetic points will help you to connect the elements exactly aligned to the pipe center and direction. With the feature "Multicopy", all selected elements stay glued to the mouse until you press "Escape". Works with 3skeng Pipe and Channel.



3skeng Label

This tool enables you to add text labels to 3skeng elements. Various adjustable parameters allow individual adaptations to the particular label task at hand. During the automated alignment you determine the position and distance of the labels. Future changes can be made in no time at all. Works with all 3skeng elements.



3skeng List (tool-specific)

The List Tool received a major redevelopment and ended up being a powerful stand-alone tool that bridges the gap between the two worlds of SketchUp and Excel and brings them together as one.

Pipe, Mount, Steelwork and Channel come with the List features for their (tool-specific) elements.

3skeng Tools - Comparison Table of 3skeng tools

	List	Pipe	Channel	Mount	Steelwork
Available for PC & MAC	✓	✓	✓	✓	✓
3skeng 2022 Tool for SketchUp 2022 to 2019	✓	✓	✓	✓	✓
3skeng 2021 Tool for SketchUp 2021 to 2018	✓	✓	✓	✓	✓
3skeng 2020 Tool for SketchUp 2020 to 2017	✓	✓	✓	✓	✓
Trial version	14 days	14 days	14 days	14 days	14 days
Available through Extension Warehouse	as link to 3skeng homepage	as link to 3skeng homepage	as link to 3skeng homepage	as link to 3skeng homepage	as link to 3skeng homepage
Available through website/client/resellers	✓	✓	✓	✓	✓
Auto-Pipe 3skeng 2019 + Reducer 3skeng 2021		✓			
Edit & Rotate		✓	✓	✓	✓
Connect (Single entity)					✓
Connect (Multicopy)		✓	✓	✓	
Label		✓	✓	✓	✓
List for SketchUp elements (Faces, Groups, Components)	✓				
List for 3skeng tool elements	✓	✓	✓	✓	✓
Speed improvement		✓	✓	✓	✓
Assigned IFC properties are kept for copied & edited elements.		✓	✓	✓	✓
Use of detail libraries		✓		✓	